

SINGER
501W1

PRICE LIST

OF

PARTS



MACHINE No. 501w1

INDEX

	PAGE
ACCESSORIES.....	9
MACHINE No. 501w1.....	7
NUMERICAL LIST OF PARTS.....	11
STARTING TREADLE.....	9

THE SINGER MANUFACTURING COMPANY

Instructions for Ordering

In ordering from this list, use **ONLY** the **PART** number in the **FIRST** column.

The number stamped on a Sewing Machine Part is the number of the Single Part only, except when the part includes Set Screws, Clamping Screws, Studs and Rollers Spun on, Small Wires riveted, or Parts soldered together, etc., which it is necessary to furnish in combination.

Every combination of parts sent out has its specific number which, although not stamped on Parts (except in above cases) must be used when ordering the combination.

Each number always indicates the **SAME PART** in whatever list it appears, or for whatever Machine.

The letters after some of the numbers indicate the style of finish only, as follows:

- A. Hardened, Polished and Plated.
- B. Polished and Plated.
- C. Hardened only.
- D. Polished only.
- E. Soft, not polished.
- F. Hardened and Polished.
- H. Blued.

These letters **MUST BE USED** when they appear in the list and **AFTER** the number, as in the list.

The figures in the second column refer only to the plate in which the illustration of the part is shown and are **NOT TO BE USED** in ordering.

Two or more numbers over a cut indicate that the difference between such parts is not visible in an illustration.

Parts marked with an asterisk (*) are furnished only when repairs are made at the factory.

LIST OF PARTS COMPLETE

FOR

MACHINE No. 501w1

For Cutting or Snipping Shoe Vamps, Etc.

No.	Plate	Name	Each
344c	14810	Belt Guide Pulley Bracket Shaft Set	
		Screw	\$ 08
260055	14809	Driving Flange	2 50
*260056	-----	" " Interlocking Pin	—
225547	14810	" " " " Spring ..	03
*260057	-----	" " " " Throw-out	—
		Segment	—
260058	14810	Driving Flange Interlocking Pin Throw-	
		out Segment Position Pin	02
260059	14810	Driving Flange Position Pin	05
260060	14809	Driving Flange complete, Nos. 225547	
		and 260055 to 260058	4 00
260061	14809	Driving Pulley (loose) with two 260062 ..	4 00
260062	14810	" " Driving Stud	15
260063	14809	" Shaft	4 00
260064	14812	" " Collar	65
260199	14810	" " " Position Pin	02
260200	14812	" " Friction Clamp with 2015S1B,	
		202104 and 260201	1 20
260201	14810	Driving Shaft Friction Clamp Pressure	
		Regulating Screw	35
2015S1B	14810	Driving Shaft Friction Clamp Pressure	
		Regulating Screw Lock Nut	12
202104	14810	Driving Shaft Friction Clamp Pressure	
		Regulating Screw Lock Nut Washer ..	01
200284D	14810	Driving Shaft Friction Clamp Screw ..	05
202104	14810	" " " " " Washer ..	01
260069	14810	" " Screw	25
260070	14810	" " " " Washer	40
*260072	-----	Frame	—
260082	-----	Knife	2 50
260076	14812	" Bar with 200347c	2 50
260011	14810	" " Driving Block	1 50
260077	14810	" " Guide Stud	10
200347c	14810	" " " " Set Screw	03
260078	14812	" Cutting Plate	30
260079	14811	" " " Clamp with 260080 and	
		260198 (2)	75
260198	14811	Knife Cutting Plate Clamp Thumb Screw	10

No.	Plate	Name	Each
260080	14811	Knife Cutting Plate Clamp Thumb Screw Washer	\$ 10
200395c	14814	Knife Holder Screw	02
200388c	14814	" " " Set Screw	02
225547	14810	" " Spring	03
260091	14814	Knife Holder complete	5 60
200729B	14811	" " Thumb Screw	20
260073	14812	Machine Starting Rod	35
260074	14811	" " " Spring	08
260075	14811	" " " " Collar with 260081	60
260081	14811	Machine Starting Rod Spring Collar Set Screw	12
260190	14809	Work Plate	5 00
260191	14812	" " Adjusting Thumb Screw	2 00
260192	14811	" " " " " Position Stud	50
206124	14811	Work Plate Adjusting Thumb Screw Position Stud Spring	03
260193	14809	Work Plate Lifting Handle	2 25
260194	14811	" " " " Stop Pin	07
260195	14811	" " Position Stud	50
200335c	14811	" " " " Set Screw	04

ACCESSORIES

No.	Plate	Name	Each
260051	14813	Belt Guide Pulley	\$ 60
260052	14813	" " " Bracket with 344c	50
344c	14810	" " " " Set Screw	08
260053	14813	" " " " Shaft	30
260196	14814	" " " Shaft	20
260014	14814	" " " " Cotter Pin	01
260015	—	" " " Washer (fibre)	05
260054	14813	Belt Guide complete, Nos. 260052, 260053, two each 260014, 260015, 260051 and 260196	2 50
36578	14813	Oiler with 36579	10
36579	14813	" Spout, 3 in. long	06
225498	14813	Screw Driver, 7½ in. long	15
225554	14814	Wrench (steel)	10
		Four wood screws 1½ in., No. 14	
STARTING TREADLE			
260186	14813	Starting Treadle	25
260187	14813	" " Bracket	25
260197	14813	" " " 260187 with 1620e, 260186, 260188, 260189 and two wood screws 1½ in., No. 14	70
232365	14813	Starting Treadle Chain (41½ in. long) with two 202784	25
202784	14814	Starting Treadle Chain Hook	02
260188	14814	" " " Screw Eye	15
1620e	14814	" " " " " Nut	03
260189	14814	" " " Hinge Pin	05

NUMERICAL LIST OF PARTS

NUMERICAL LIST OF PARTS FOR MACHINE No. 501w1

No.	Plate	Name	Each
341c	14810	Belt Guide Pulley Bracket Set Screw, for 260052	\$ 08
341c	14810	Belt Guide Pulley Bracket Shaft Set Screw	08
1620e	14814	Starting Treadle Chain Screw Eye Nut, for 260197	03
36578	14813	Oiler with 36579	10
36579	14813	" Spout, 3 in. long, for 36578	06
200284b	14810	Driving Shaft Friction Clamp Screw	05
200335e	14811	Work Plate Position Stud Set Screw	04
200347c	14810	Knife Bar Guide Stud Set Screw, for 260076	03
200388c	14811	Knife Holder Screw Set Screw	02
200395e	14811	" " "	01
200729b	14811	" " Thumb Screw	20
201581b	14810	Driving Shaft Friction Clamp Pressure Regulating Screw Lock Nut, for 260200	12
202104	14810	Driving Shaft Friction Clamp Pressure Regulating Screw Lock Nut Washer, for 260200	01
202104	14810	Driving Shaft Friction Clamp Screw Washer	01
202784	14814	Starting Treadle Chain Hook, for 232365	02
206424	14814	Work Plate Adjusting Thumb Screw Posi- tion Stud Spring	03
225498	14813	Screw Driver, 7 $\frac{1}{4}$ in. long	15
225547	14810	Driving Flange Interlocking Pin Spring, for 260060	03
225547	14810	Knife Holder Spring	03
225554	14814	Wrench (steel)	10
232365	14813	Starting Treadle Chain (41 $\frac{1}{2}$ in. long) with two 202784	25
260011	14810	Knife Bar Driving Block	1 50
260014	14814	Belt Guide Pulley Shaft Cotter Pin, for 260054	01
260015	—	Belt Guide Pulley Washer (fibre), for 260054	05
260051	14813	Belt Guide Pulley, for 260054	60
260052	14813	" " " Bracket with 341c, for 260054	50
260053	14813	Belt Guide Pulley Bracket Shaft, for 260054	30
260054	14813	Belt Guide complete, Nos. 260052, 260053, two each 260014, 260015, 260051 and 260196	2 50

Numerical List of Parts

No.	Plate	Name	Each
Nos. 260055 to 260058, for 260060.			
260055	14809	Driving Flange	\$2 50
*260056	—	" " Interlocking Pin	—
*260057	—	" " " " Throw-out Segment	—
260058	14810	Driving Flange Interlocking Pin Throw- out Segment Position Pin	02
260059	14810	Driving Flange Position Pin	05
260060	14809	Driving Flange complete, Nos. 225547 and 260055 to 260058	4 00
260061	14809	Driving Pulley (loose) with two 260062..	4 00
260062	14810	" " Driving Stud, for 260061 ..	15
260063	14809	" Shaft	4 00
260064	14812	" " Collar	65
260069	14810	" " Screw	25
260070	14810	" " " Washer	40
*260072	—	Frame	—
260073	14812	Machine Starting Rod	35
260074	14811	" " " Spring	08
260075	14811	" " " " Collar with 260081	60
260076	14812	Knife Bar with 200347c	2 50
260077	14810	" " Guide Stud	10
260078	14812	" Cutting Plate	30
260079	14811	" " " Clamp with 260080 and 260198	75
260080	14811	Knife Cutting Plate Clamp Thumb Screw Washer, for 260079	10
260081	14811	Machine Starting Rod Spring Collar Set Screw, for 260075	12
260082	—	Knife	25
260091	14814	Knife Holder complete	5 60
260186	14813	Starting Treadle, for 260197	25
260187	14813	" " Bracket, for 260197	25
260188	14814	" " Chain Screw Eye, for 260197	15
260189	14814	Starting Treadle Hinge Pin, for 260197 ..	05
260190	14809	Work Plate	5 00
260191	14812	" " Adjusting Thumb Screw	2 00
260192	14811	" " " " " Posi- tion Stud	50
260193	14809	Work Plate Lifting Handle	2 25
260194	14811	" " " " Stop Pin	07
260195	14811	" " Position Stud	50
260196	14814	Belt Guide Pulley Shaft, for 260054	20
260197	14813	Starting Treadle Bracket 260187 with 1620e, 260186, 260188, 260189 and two wood screws 1½ in., No. 14	70

Numerical List of Parts

No.	Plate	Name	Each
260198	14811	Knife Cutting Plate Clamp Thumb Screw, for 260079	\$ 10
260199	14810	Driving Shaft Collar Position Pin	02
260200	14812	" " Friction Clamp with 201581b, 202104 and 260201	1 20
260201	14810	Driving Shaft Friction Clamp Pressure Regulating Screw, for 260200	35

**ILLUSTRATIONS OF PARTS
FOR
MACHINE No. 501 w1**

260061

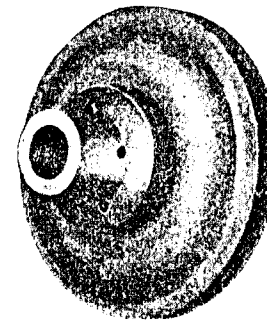

260055

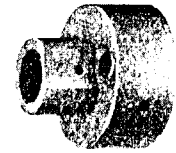

260063



260190

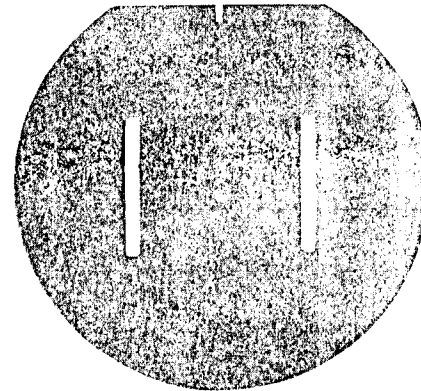

260193



260060

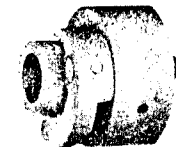

PLATE 14810-FULL SIZE

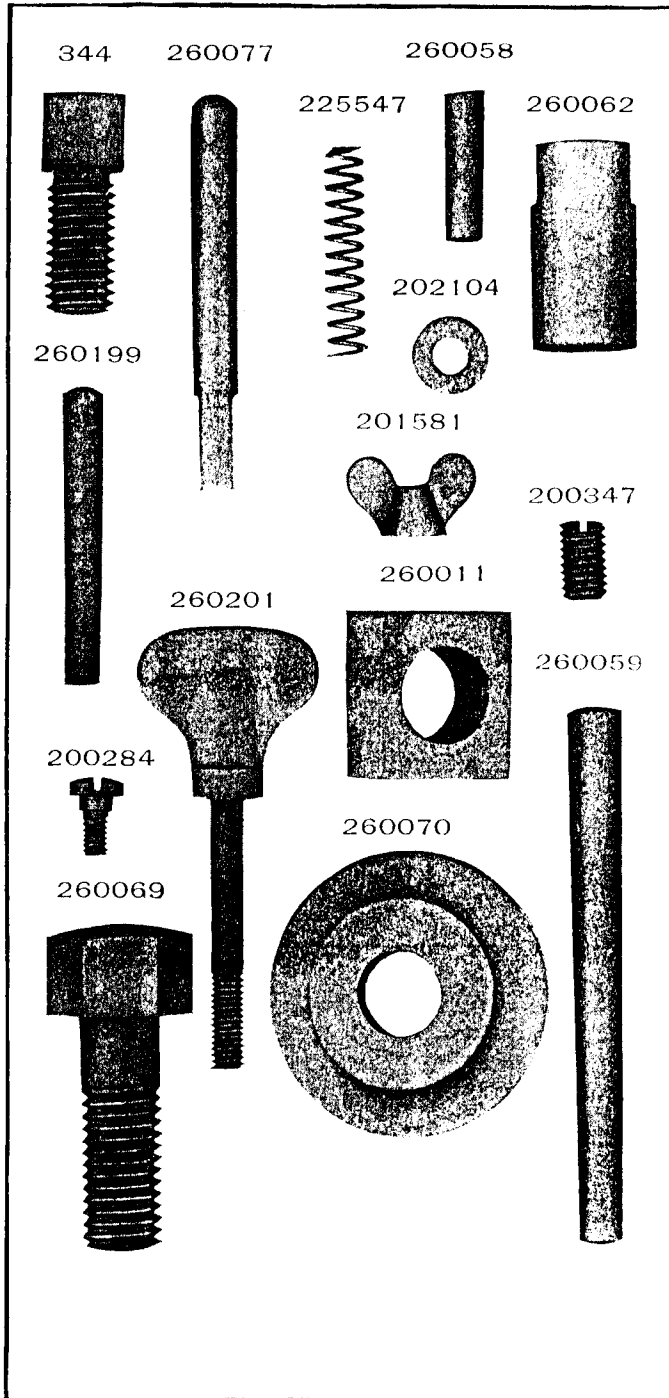

PLATE 14811-FULL SIZE

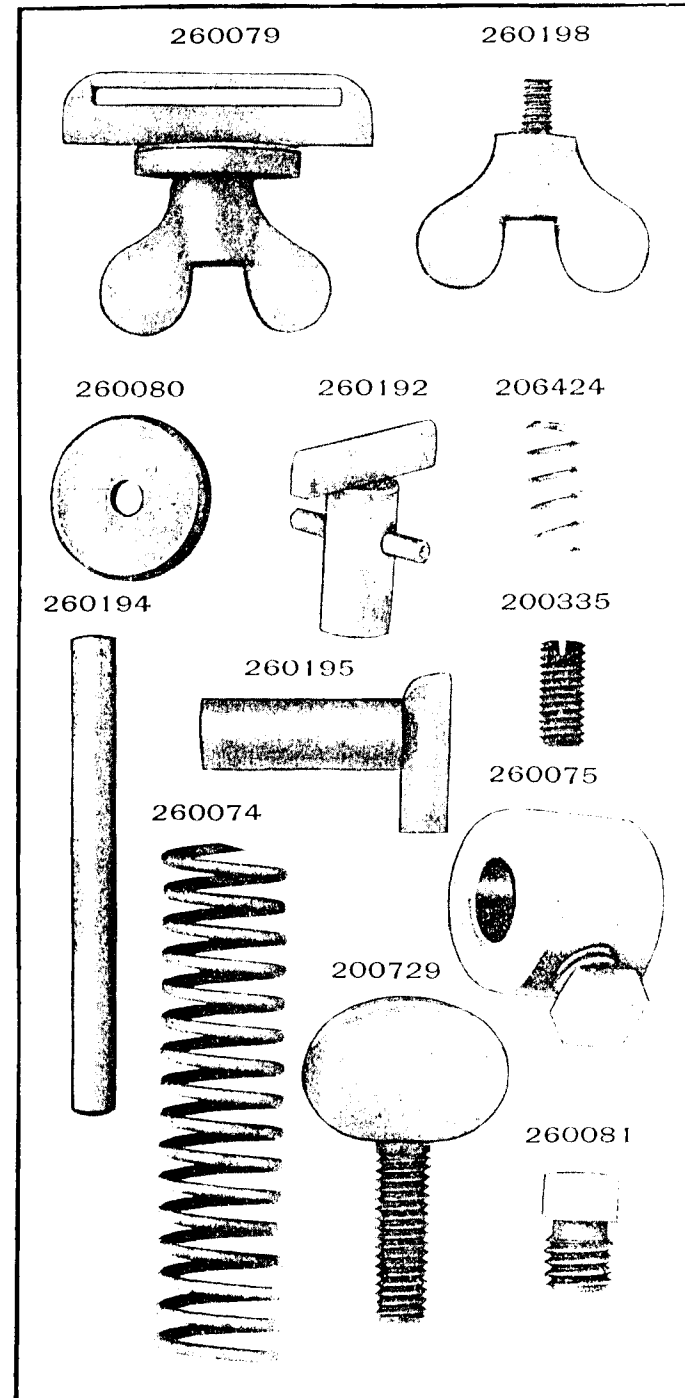

PLATE 14812—ONE-HALF SIZE

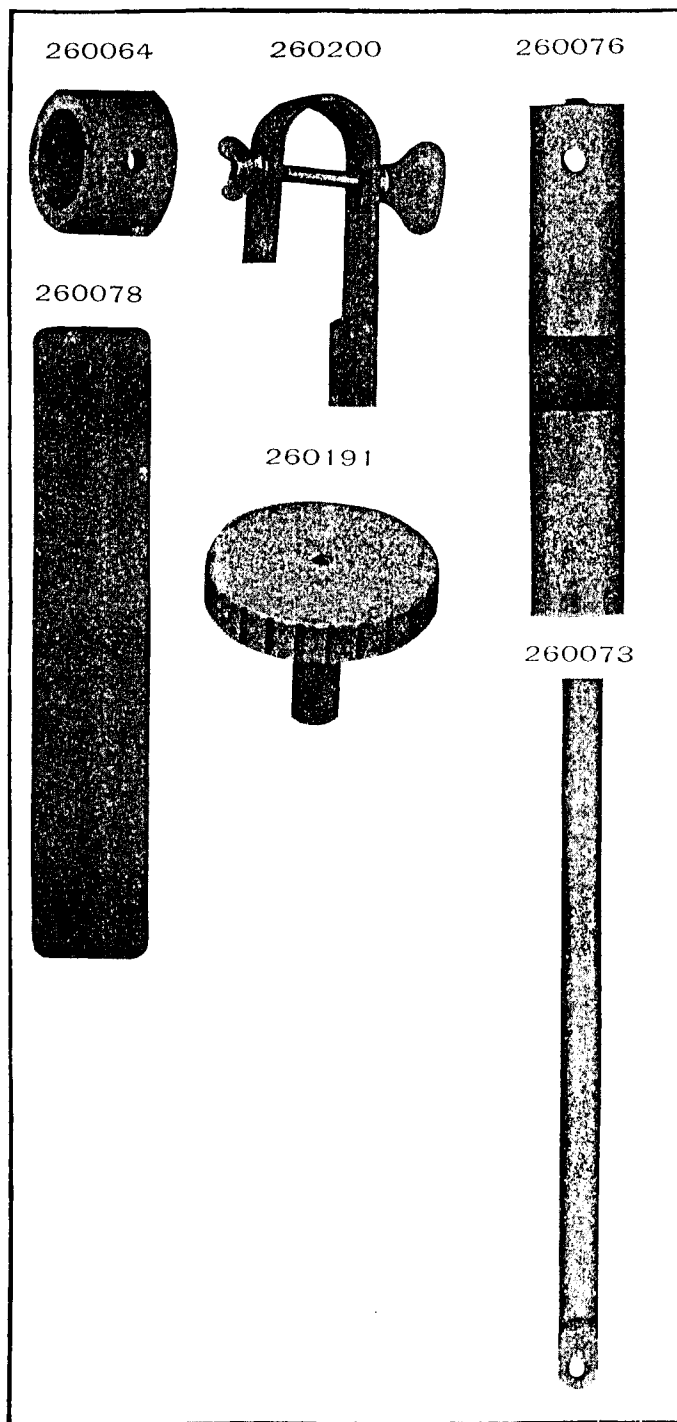

PLATE 14813—ONE-FOURTH SIZE

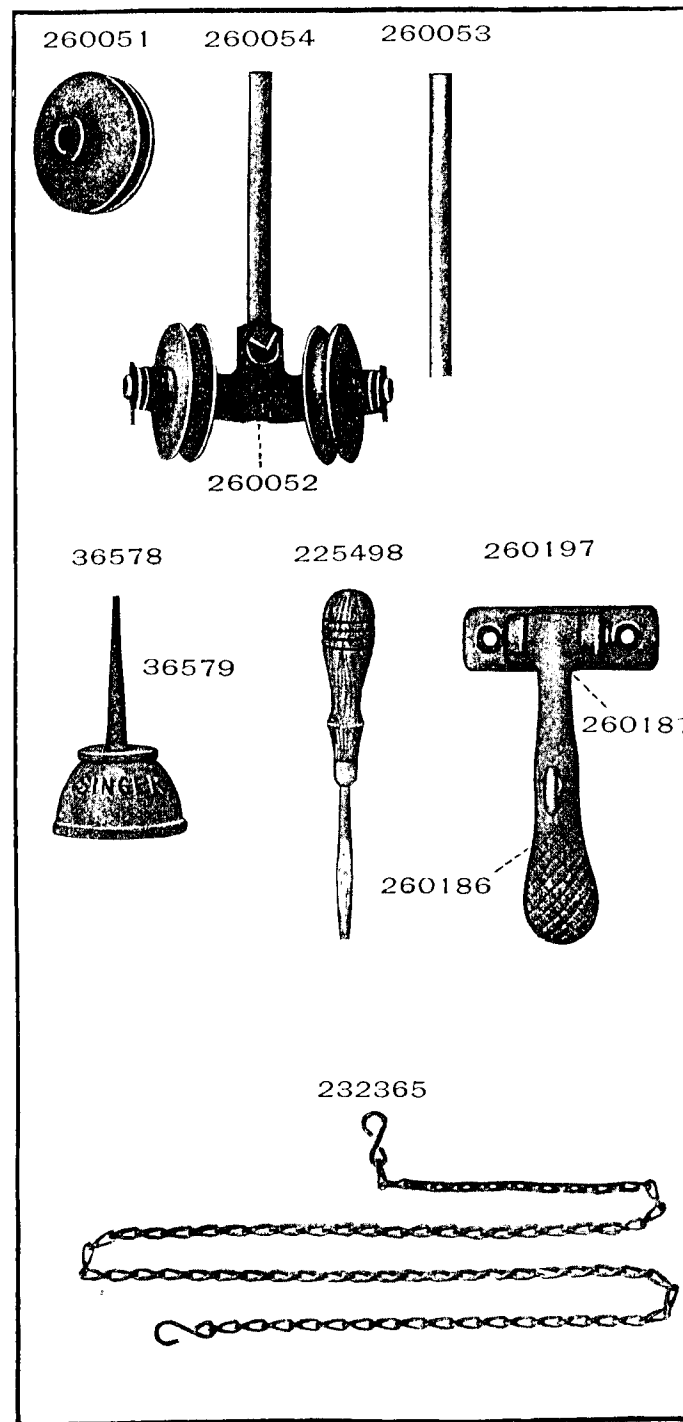
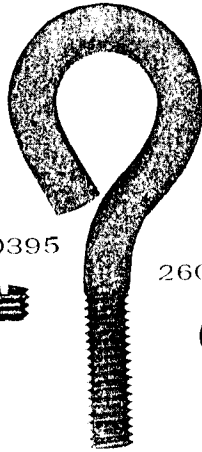

PLATE 14814-FULL SIZE

260196



260188



200395



260014



1620



200388



260189



225554

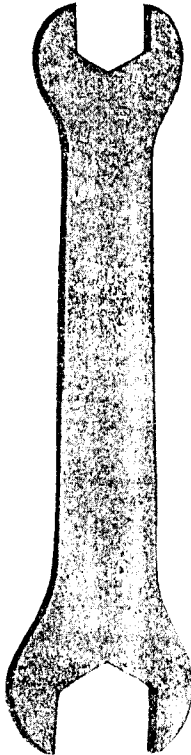

260091

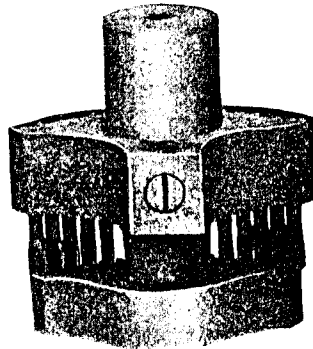

260091

